

KNC-PKS-FD322S-04 - Servo System



FEATURES

- 88-126VAC Single-Phase Input Voltage
- Rated Torque of 1.27 Nm
- Power Ratings up to 400 Watts
- 2,500 PPR Incremental Encoder
- Maximum Speed of 3000 RPM
- IP65 for Body, IP54 Shaft Seal
- Brake Option Available
- Position, Speed, and Torque Control
- RS232 and RS485 Port



DESCRIPTION

The PKS-FD322S-04-60S-AAK-AKH Servo System includes a 400 Watt SMH60S-0040 AC Servo Motor operated by the FD322S-LA-000 Drive. These packages are ideal and easy start-ups, convenience, and performance. The Servo Motors included in these packages provide torque up to 1.27 Nm. The FD322S-LA-000 Drive offers current forward-feedback control, acceleration forward-feedback control, speed viewer, and inertia viewer; providing for improved response performance. Each system includes a 5m Motor Power Cable and a 5m Encoder Cable. If purchasing the option with a Brake then a 5m Brake Cable will be included as well.

Item	Rated Voltage (VAC)	Rated Speed (RPM)	Rated Torque (NM)	Rated Current (Arms)	Inertia (oz-in-sec ²)	Torque Constant KT (oz-in/A)	Resistance (ohms)	Inductance (mH)	Brake (24VDC)	Motor Length (mm)	Shaft Diameter (mm)
PKS-FD322S-04-60S-AAK-AKH	88-126	3000	1.27	4	0.0067	46.87	1.7	3.5	No	150	14
PKS-FD322S-04-60S-ABK-AKH	88-126	3000	1.27	4	0.0067	46.87	1.7	3.5	Yes	190	14

ORDERING INFORMATION

PKS-FD322S-04-60S-AAK-AKH

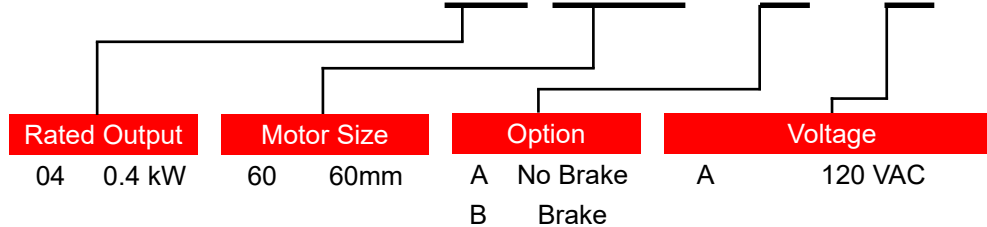

L011569

SMH60S-0040 Motor Specifications



FEATURES

- 220 VAC
- 400 W Power Rating
- Rated Torque of 180 oz-in
- Maximum Speed of 3000 rpm
- 2500 PPR Incremental Encoder Attached
- IP65 for Body, IP54 Shaft Seal
- Brake Option Available
- CE Certified



SPECIFICATIONS

Item	Rated Torque (NM)	Rated Power (Watts)	Rated Speed (rpm)	Rated Current (Arms)	Inertia (oz-in-sec ²)	Torque Constant KT (oz-in/A)	Resistance (ohms)	Inductance (mH)	Length (mm)	Weight (lbs)
SMH60S-0040-30AAK-3AKH	1.27	400	3000	4	0.0067	46.87	1.7	3.5	150	3.97
SMH60S-0040-30ABK-3AKH	1.27	400	3000	4	0.0067	46.87	1.7	3.5	190	5.07

DIMENSIONS

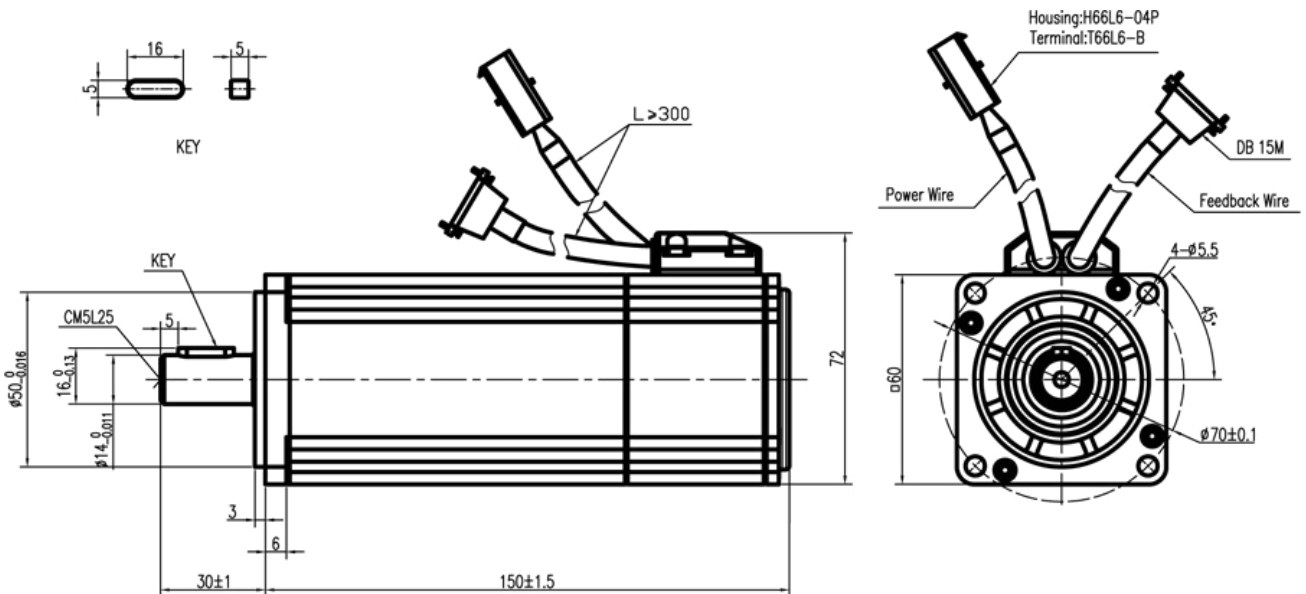

Note: Part Number SMH60S-0020-30ABK is with the brake option. Brake option not shown in above dimensions.

Dimensions are in mm

FD322S-LA-000 Driver Specifications



FEATURES

- Input Voltage Range of 88-126VAC
- 400 W Power Rating
- Rated Torque of 180 oz-in
- Maximum Speed of 3000 rpm
- 2500 PPR Incremental Encoder Attached
- IP65 for Body, IP54 Shaft Seal
- Brake Option Available
- Position, Speed, and Torque Control
- CE Certified



DIMENSIONS

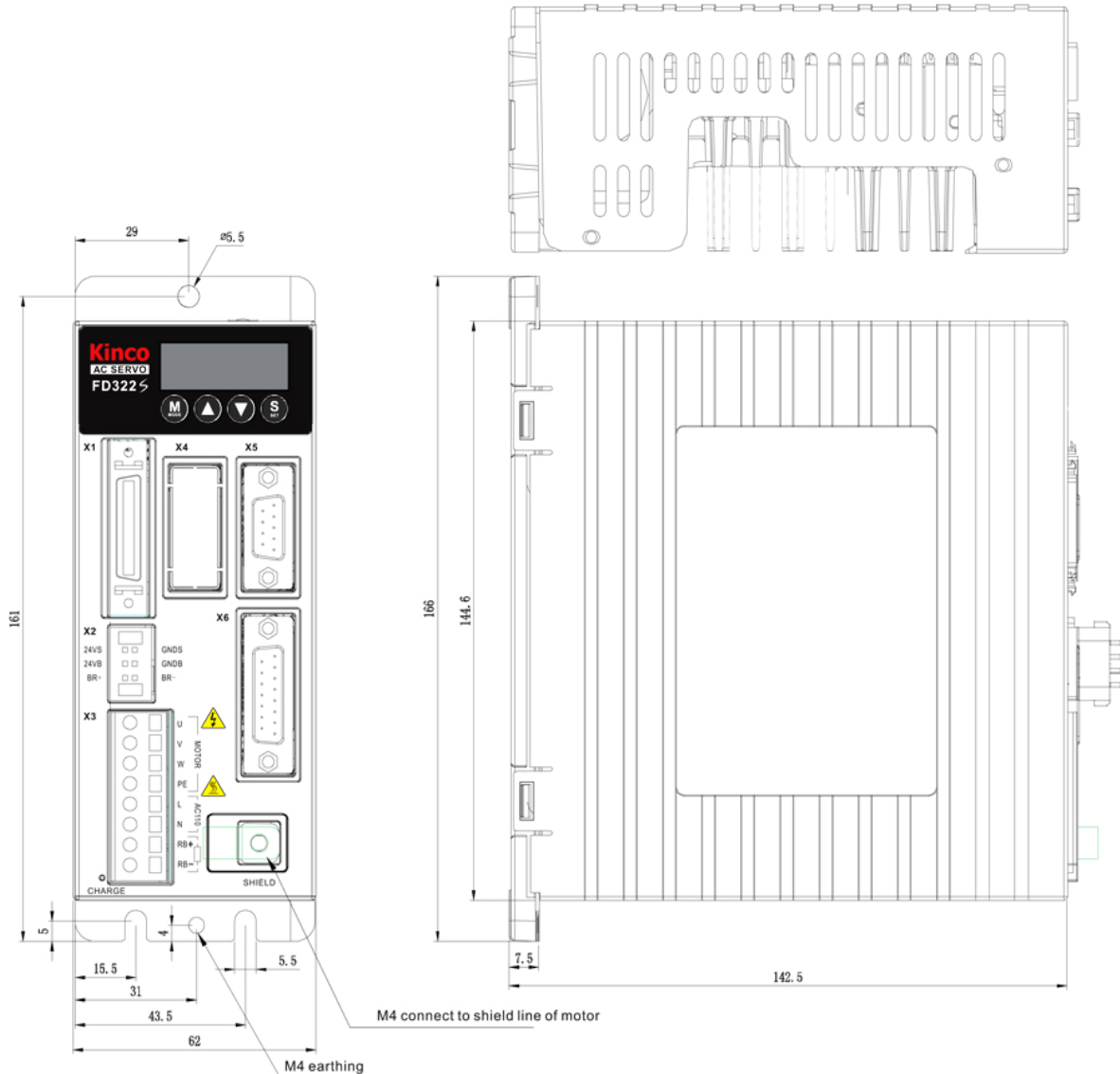

Dimensions are in mm

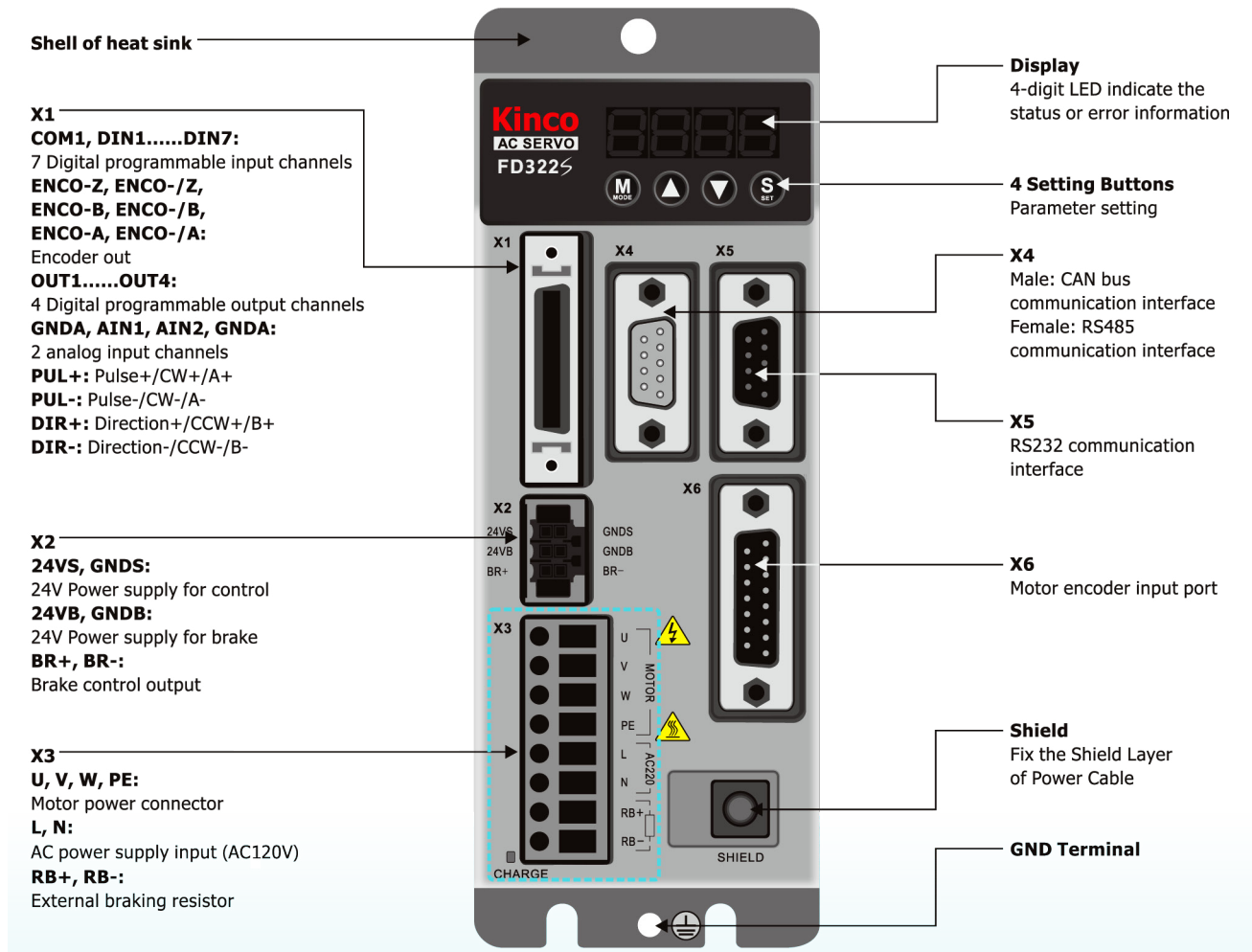

Digital Input/Output Port

PIN No.	Signal	PIN No.	Signal	PIN No.	Signal	PIN No.	Signal	
2	COM1	1	OUT1+	20	NC	19	AIN1	
4	DIN1	3	OUT1-	22	NC	21	GNDA	
6	DIN2	5	OUT2+	24	GND	23	AIN2	
8	DIN3	7	OUT2-	26	ENCO-Z	25	GNDA	
10	DIN4	9	OUT3	28	ENCO-/Z	27	PUL+	
12	DIN5	11	OUT4	30	ENCO-B	29	PUL-	
14	DIN6	13	COM0	32	ENCO-/B	31	DIR+	
16	DIN7	15	NC	34	ENCO-A	33	DIR-	
18	NC	17	CAN	NC	36	ENCO-/A	35	NC

X1

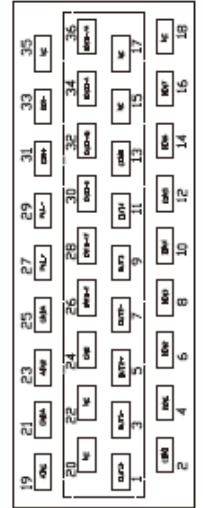

PIN Number	Signal
1	NC
2	CAN_L
3	GND
4	NC
5	NC
6	NC
7	CAN_H
8	NC
9	NC

CAN

PIN Number	Signal
1	NC
2	RX+
3	TX+
4	NC
5	GND
6	+5V
7	RX-
8	TX-
9	NC

RS485

X4

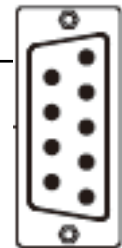

9 pin DB

RS232

PIN Number	Signal
1	NC
2	TX
3	RX
4	NC
5	GND
6	NC
7	NC
8	NC
9	NC

*Note: The CAN option is available only for the AA and the CA versions

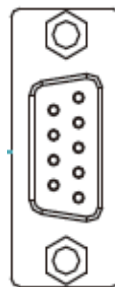

9 Pin DB Female

X5

ENCODER IN

PIN No.	Incremental Encoder Signal	PIN No.	Incremental Encoder Signal	PIN No.	Communication Encoder Signal	PIN No.	Communication Encoder Signal
1	+5V	9	GND	1	+5V	9	GND
2	A	10	/A	2	NC	10	NC
3	B	11	/B	3	NC	11	NC
4	Z	12	/Z	4	NC	12	NC
5	U	13	/U	5	NC	13	NC
6	V	14	/V	6	NC	14	NC
7	W	15	/W	7	SD	15	/SD
8	PTC_IN			8	NC		

X6

Motor Encoder Input Port

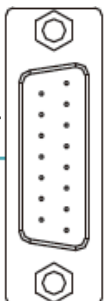

15 Pin DB Female

Compatible Drivers

Part Number	Description
FD322S-LA-000	Servo Driver



Compatible Motors

Part Number	Description
SMH60S-0040-30AAK-3AKH	Servo Motor
SMH60S-0040-30ABK-3AKH	Servo Motor



Compatible Cables

Part Number	Description
ENCCA-05-KH	Encoder Cable
MOT-005-05-KL	Power Cable
BRA-05-KL	Brake Cable

